

SMOKER
CRAFT

LEVEL
SMOKER

2023
ALUMINUM FISHING BOATS

More than one hundred years and five generations in pursuit of our passion.



Tradition begins with the family.

We're not just boat builders. We're boaters, just like you. For five generations and counting, our family has been dedicated to sharing the wonder of boating by creating the finest watercraft that money can buy. That's really all there is to it.

Smoker Craft can trace its roots in the boating industry all the way back to 1921, when the Smoker Lumber Company, as it was then called, was a world leader in the production of oars and paddles. We also built many of the wooden components used in boats produced by several different brands. So in 1963, we built on those four decades of experience and began making boats of our own.

ventilates storage compartments so that gear put away wet doesn't stay that way. Our history is one of constant innovation, and that only results from spending time on the water.

While our designs have evolved over the years, what has remained constant is the painstaking care and meticulous attention to detail that goes into crafting every single one of our boats. Many of our more than 900 employees have been with us for 30 years or more, and their skill and craftsmanship is unmatched in the industry.

We love boating, and we want to share it with the world. That is our commitment. That is our heritage.

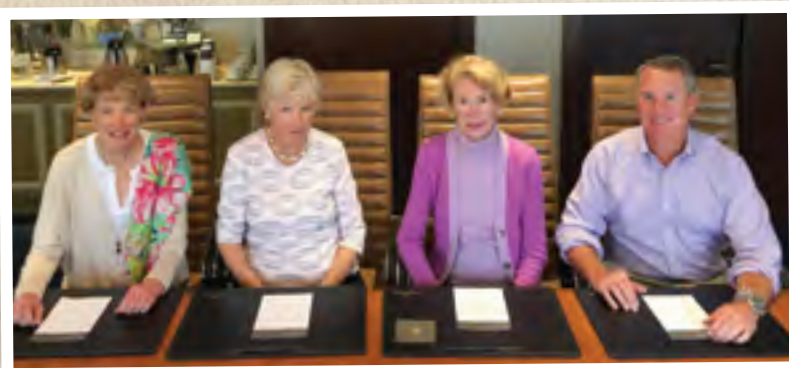

Cinda McKinney,
Susan Graff,
Sara Barrett and
Peter Barrett

Although most boats at that time were made entirely from wood, we chose aluminum for its light weight, great strength and maintenance-free durability. Then we added our own innovations, like our Performance Hull System and our acclaimed Hydra-Lift reverse chine hull, our pinch-free seating that protects stray fingers and fishing rod tips from harm, retractable cleats to avoid snagging fishing lines or stubbing toes, and our revolutionary Yarblow system that



President
Doug Smoker
with grandson
Henry Smoker



STANDING STRONG ON FOUR FOUNDATIONS.

Fishing isn't just something you do. It's part of who you are. So when it comes to choosing a fishing boat, second best won't do. That's why, for more than 100 years, Smoker Craft has pushed boundaries with our spacious interior layouts and industry-leading hull designs that deliver superior performance and fuel economy. That's why we continue to drive innovation with features like our Yarblow ventilation system that protects expensive tackle from rust and corrosion, our advanced FreshCatch and FreshCatch Pro livewell systems to keep the catch fresh all the way to the table or the tournament weigh-in, and our Integrated Gunnel Track System (IGTS) that lets you mount accessories anywhere without having to drill any holes. We get this stuff because we're anglers too. That's why we're constantly taking things to the next level with design, engineering and construction that deliver best-in-class aluminum fishing boats for every budget.

THE INDUSTRY'S BEST WARRANTY. PERIOD.

Only a company with the proven history and longevity of a brand like Smoker Craft can offer something like this:

- Limited lifetime warranty on hull and structure
- 6-year warranty on all components, carpet and upholstery*
- All parts and labor
- Transferable to second owner



LIVEWELLS

What's the point in having a livewell if you have to constantly fuss with it? Our FreshCatch Pro recirculating livewells use heavy-duty pumps and PowerStream aerators to move more oxygenated water through the tank and keep fish healthy. Just hit the timer and forget it, so you can focus on the fish below the boat — not the fish that are already in it.



BOW PLATFORMS

Our raised bow casting platforms are carefully designed to give you plenty of elevation for better visibility and more storage space, while maintaining plenty of interior depth for added safety and a dry ride in rough conditions. Our exclusive raked bow design gives you more interior space up front, allowing larger in-deck storage compartments for storing bulky items.



ROD STORAGE

Our rod storage spaces are designed to protect expensive tackle from damage while keeping it readily available for instant access. Select models feature lockable bow in-floor center storage that holds up to eight rods securely in individual tubes.

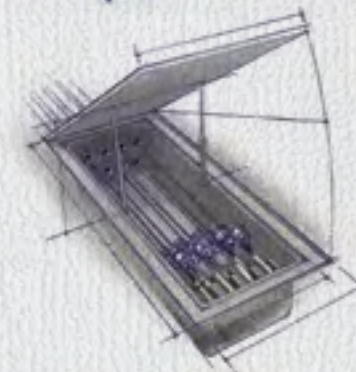

CONSOLES

Smoker Craft deluxe consoles put everything you need just a glance away. Their ergonomic designs position gauges so they're clearly visible while running, and toggle switches are always within easy, unobstructed reach. Hydraulic steering comes standard or is an option on many models.



Team SMOKER CRAFT



Jason Leatherman



Jake Romanack



Travis White



Follow Averie Rose



MEET THE SMOKER CRAFT PRO FISHING TEAM

Richard Brouwer
St. Catharines, Ontario, Canada

Averie Rose
Port Rowan, Ontario, Canada

Mat Koprash
North Bay, Ontario, Canada

Eric Rossi
Goshen, IN

Jason Letherman
Three Oaks, MI

Phil Sedelmaier
Kaleva, MI

Ben Plating
Oswego, IL

Travis White
Houghton, MI

Mike Reesor
Bobcaygeon, Ontario, Canada

Greg Yarbrough
Port Clinton, OH

Jake Romanack
Tustin, MI

Gary Zart
Parma, OH

Mark Romanack
Tustin, MI

Separating ourselves from the pack

Since 1921, Smoker Craft boats have stood for continuous innovation, standing out from the pack with numerous key features that make a big difference out on the water. Designed by anglers for anglers, here's just a sample of what you'll find on our 2023 lineup.

C-ZONE DIGITAL WIRING SYSTEM

Simplify your boat's operation system with C-Zone digital wiring. C-Zone gives you complete control of all electrical functions with the touch of a button. From monitoring pump levels, battery levels and other critical functions, to optimizing the onboard environment via a multi-circuit switch, you can take your boat to the next level of performance and sophistication when you let C-Zone do the thinking.



Scan the code to learn more:



INTEGRATED GUNNEL TRACK SYSTEM

Smoker Craft's exclusive Integrated Gunnel Track System (IGTS) allows for easier installation of rod holders, downriggers and other accessories – without drilling a single hole anywhere in the boat. IGTS is the ideal foundation for factory-installed accessory packages from Bert's Custom Tackle, developed by legendary fishermen to meet the individual needs of serious anglers. Ask your dealer for details.



.YARBLOW. VENTILATION SYSTEM

Optional on **Ultima** and **Pro Angler XL** series boats.

Let's face it, on a fishing boat, gear sometimes gets put away wet. That's why Smoker Craft is proud to offer the exclusive Yarblow Ventilation System that circulates fresh air through rod lockers and storage spaces to protect expensive tackle from rust and corrosion. Pressurized air keeps mold and mildew from becoming established in storage compartments, as well as traditionally wet areas like the bilge, protecting your gear and the boat itself. It's all part of our commitment to providing peace of mind and giving you more value for your investment.

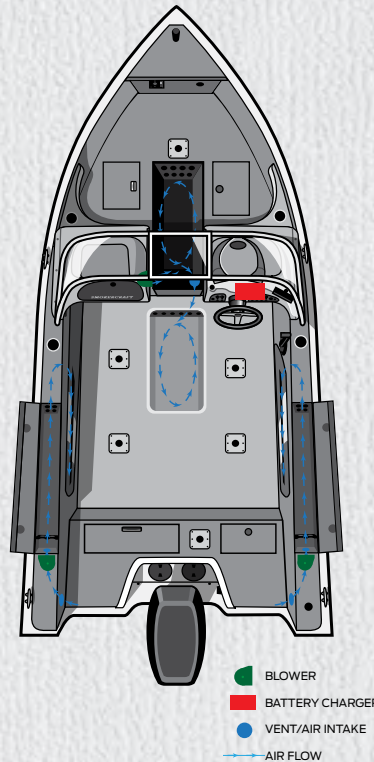

To see more information on our fine Smoker Craft fishing boats, visit SMOKERCRAFT.COM.

CONSTRUCTION YOU CAN COUNT ON.

UPHOLSTERY

Produced in-house for quality control and customization, Smoker Craft upholstery is precision cut and installed using only stainless, non-corrosive fasteners. Cushioning foam is biocide treated to help prevent mildew and fungal growth that can discolor vinyl. This process is a key differentiator when comparing Smoker Craft to other manufacturers.

CARPET & VINYL

Smoker Craft casting platforms and decks are covered in marine-grade carpet that is both glued and stapled, while cockpits feature easy-to-clean vinyl. Optional snap-in carpet can be added over the vinyl for added comfort.

EVA SOFT TOUCH TRACTION MATS

These mats are easy to clean; resistant to mold, mildew and stains; and offer superior wet or dry traction.

FLOOR PANELS

Our pressure-treated plywood floors are 5/8" in the cockpit and 3/4" on the casting decks. They carry a lifetime warranty and will not warp or rot.

INJECTED FOAM FLOTATION

Unlike other manufacturers, we inject foam flotation into pre-routed holes in the floor panels to fill the entire cavity under the floor. The adhesive property of our foam allows it to bond to both the floor panels and the hull, providing enhanced support and excellent sound dampening.

TWICE-BAKED PAINT FINISH

The Smoker Craft paint method includes 3 coats of base urethane and 3 coats of accent color, with baking under infrared heating coils after each step – giving it a twice-baked, diamond-hard finish that is resistant to chipping and fading, and looks great for years to come.

ZINC CHROMATE PRIMER

Zinc chromate primer is chemically etched into the aluminum hull, forming a corrosion-resistant surface. This also creates an even, bondable surface for the final paint layer.

HIGH-GRADE ALUMINUM

Smoker Craft boats start with 5052 H34 Cold-Rolled Aluminum for its superior strength, hardness and corrosion resistance. Computerized fabrication equipment delivers precision components and ensures consistent quality.

DOUBLE RIVETS

The sides and transom are riveted with a double row of airplane-style rivets on the seams on all models 17' and above. The rows are offset to completely seal the seam.

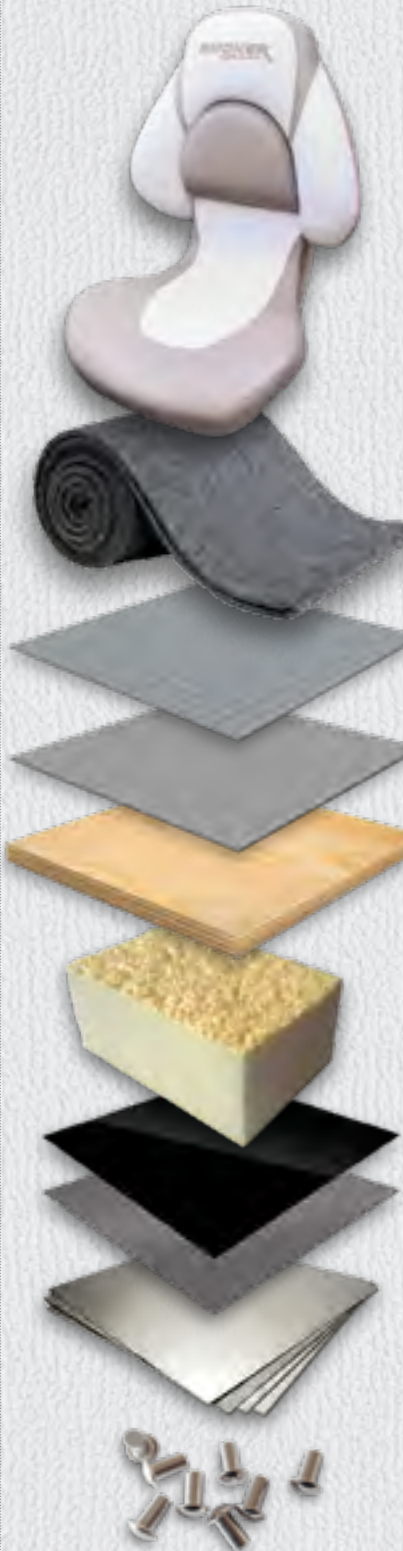

GENERATION 2 VERTEX PERFORMANCE STRAKE™ HULL

Available on the Adventurer and Excursion Series boats.

Smoker Craft's revolutionary Generation 2 Vertex Performance Strake™ (VPS) hull sets the standard for high performance in aluminum fishing boat design, providing unrivaled acceleration, unequalled handling and the highest ride quality in the industry.

Specially designed, integrated performance strakes mounted to the V-shaped hull feed nothing but clean, undisturbed water to the propeller for maximum bite. That means enhanced boat controls, greater bow lift and a quicker time to plane – even when running with less horsepower.

Break out to the big water, and you'll immediately feel the VPS difference, with its unprecedented stability and its higher, drier ride. That's something everyone can appreciate.



ENGEL LIVE BAIT WELL
with 12V plug

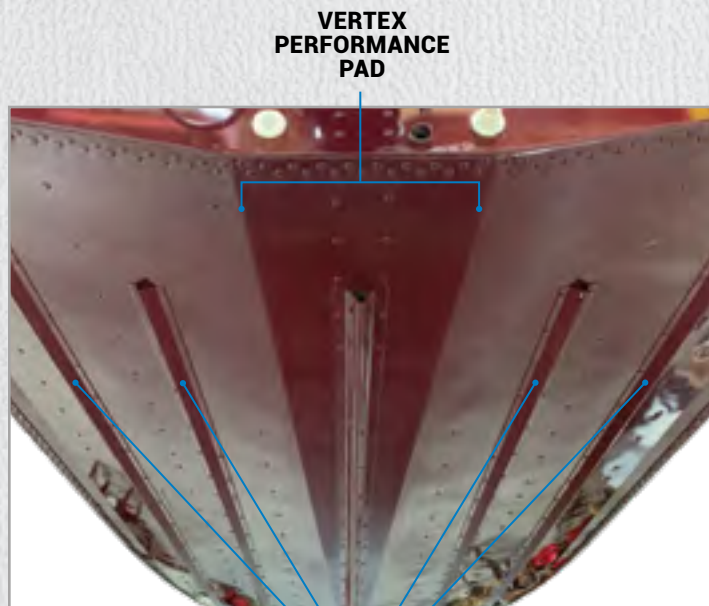

VERTEX PERFORMANCE PAD

LIFTING STRAKES

EASY ACCESS TO LIVEWELL FITTINGS

EASY PUMP ACCESS

TRANSOM BRACES
5 transom braces tied to the longitudinal structure



HORIZONTAL TRANSOM BRACES
Tied to the 5 transom braces



WIRE CHASE



WIRE CHASE

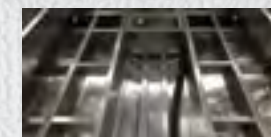

LONGITUDINAL STRUCTURE
6 beams in total with 3 on each side of center



FULL FLOTATION FOAM
Exceeds Coast Guard regulations



INTEGRATED GUNNEL TRACK SYSTEM (IGTS)



BOW RIBS
6 total ribs running 3" apart on each side of center

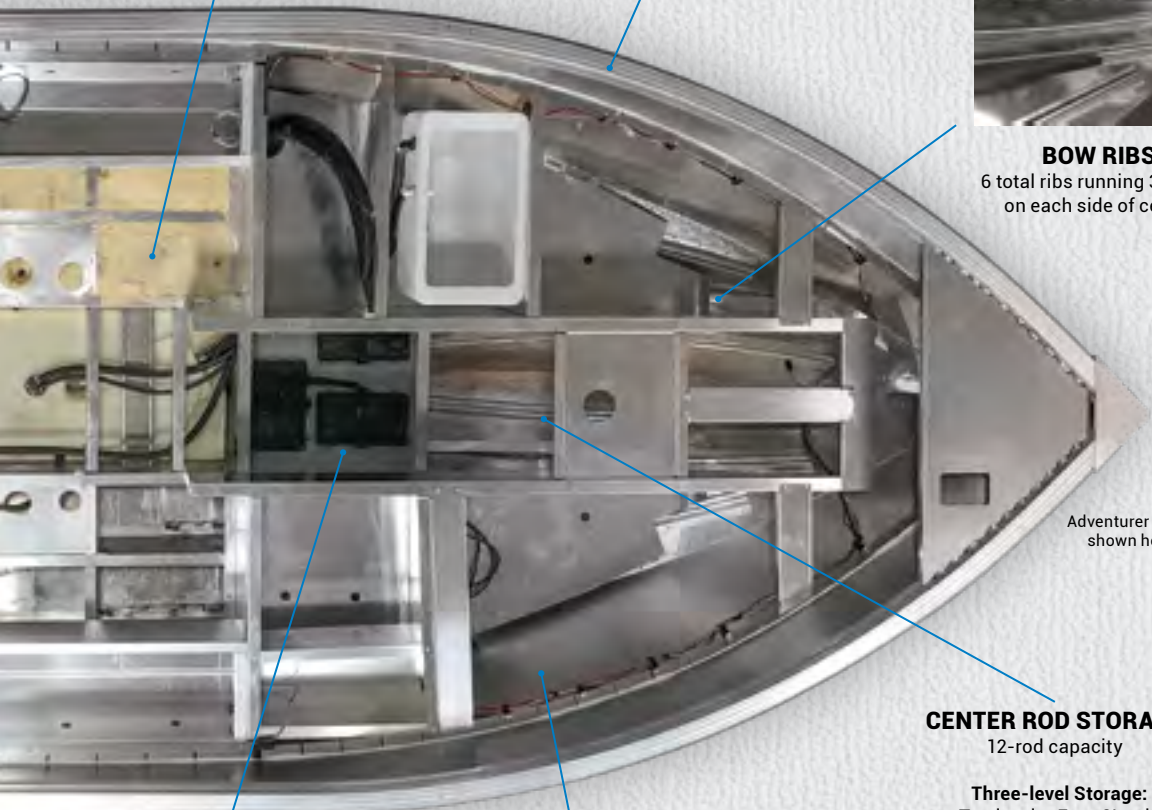

Adventurer 188 T shown here

CENTER ROD STORAGE
12-rod capacity

Three-level Storage:
Top level – Four 8' rods
Middle level – Four 7' rods
Lower level – Four 6.5' rods

BATTERY STORAGE
Placed mid-ship for better weight distribution

ONE PIECE HULL BOTTOM

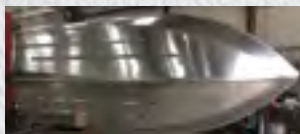

FAST DRAIN SYSTEM (FDS)
Our enhanced system quickly routes water from the main floor to the bilge through specially designed channels in the cockpit.



TOE KICKS
Toe kicks are strategically placed throughout the cockpit, providing top storage and additional safety.



FISHERMAN TOPS
Optional fisherman tops feature removable clear-view port and starboard visors. Plus, fast-open side curtains make it easy to reach outside for docking.



CONVENIENT STORAGE
Standard on Adventurer and Excursion Pro models, convenient storage compartments are perfect for Plano tackle trays and other fishing accessories.

FRESHCATCH
Our aerated livewells are timed for convenience and feature a PowerStream nozzle, a single bilge and black thru-hulls.

Standard on Excursion



FRESHCATCH PRO
Our pro livewells are aerated, timed and feature a recirculating pump to move more water and oxygen into the tanks to keep fish active. Highlights include black thru-hulls and PowerStream aerator and nozzle.

Standard on Adventurer



GENERATION 1 HYDRA-LIFT PERFORMANCE HULL

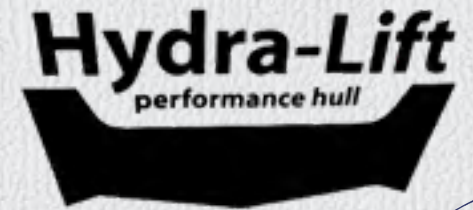

Our exclusive, proven-performance Generation 1 hull provides superior lift to get you out of the hole and on plane quickly. The reverse chine design keeps the bow down during acceleration, provides sportscar-style turning agility and offers exceptional stability both while running at high speeds and while at rest.

Generation 1 Hydra-Lift Performance Hulls are available on Ultima and Pro Angler XL Series boats.

TRANSOM

The transom board is made of 1.5" pressure-treated plywood, which is covered by our Limited Lifetime Warranty. The board is sandwiched between the aluminum transom with a plastic layer to prevent corrosion and a second aluminum sheet is anchored using stainless steel bolts.



PERFORMANCE HULL SYSTEM

Our exclusive Performance Hull System (PHS) is a completely customizable trim tab feature that increases speed, reduces pounding, eliminates porpoising and provides improved efficiency with less fuel consumption and engine laboring. The system allows you to tune your hull to maximize performance, depending on the weight and horsepower of your engine. Additional benefits include improved visibility, reduced wake size, better handling and less hull stress. *Not available on Adventurer series.*



SPRAY RAILS

Spray rails are rolled into the side panels, giving a much cleaner appearance and eliminating the line-breaking rough edges found on many other boats. The combination of spray rails with the Hydra-Lift reverse chine design delivers the driest ride in the industry.

YARBLOW. VENTILATION SYSTEM

The exclusive Yarblow Ventilation System protects your tackle and gear from rust and corrosion by using pressurized air to eliminate mold and mildew in the bilge and dry storage areas. See page 5 for more details.



SIDE PANELS

The side panels are strengthened by rolling lap strakes into the aluminum, adding rigidity to the sides that prevents the "oil can" appearance of many other boats.



INTEGRATED GUNNEL TRACK SYSTEM

The exclusive Integrated Gunnel Track System (IGTS) is an innovative gunnel design that allows for easier installation of rod holders, downriggers and other accessories. See page 5 to learn more about this exciting new feature.



LED LIGHTING

Enjoy the added style, safety and convenience of interior LED lighting.



Because the hottest bite can be early in the day or well after dark, select Smoker Craft boats feature state-of-the-art LED interior lighting for added safety and convenience. Unlike traditional courtesy lights, LEDs draw very little power, and you'll never need to replace a bulb again.

GAS TANK INTEGRATION

We place the gas tanks below the floor toward the center of the boat, between the floor stringers, to centralize the weight of the fuel. This gives the boat a softer ride and helps keep the bow down.

ONE-PIECE BOTTOM

The Hydra-Lift Hull begins with a one-piece bottom, unlike many other manufacturers. Aluminum gauge ranges from .100" to .125".



The Hydra-Lift Hull is supported by Smoker Craft's exclusive Advanced Integrated Rib System (AIRS). This integrates heavy machine-formed, hat-shaped ribs in the bow with cross ribs on 10" centers on the bottom. The bow ribs conform to the contour of the bow and angle toward the cross ribs to add strength to the critical area of the hull when the boat is running. Floor stringers are fastened to the cross ribs to support the floor panels and enhance hull strength.



5-KEEL CONSTRUCTION

While many manufacturers have stopped adding keels, we continue to use up to 5 keels on our hulls to provide longitudinal strength and to protect the bottom when beaching or trailering. In addition, the keels help the boat plane quickly by breaking the water during acceleration. They also improve tracking and help maintain better boat control while fishing.



INNER STRENGTH

The legendary performance of Smoker Craft boats comes from the tremendous strength of their proven hull design. A precision-welded framework built on longitudinal stringers is directly secured to the hull plate to create a solid, uniform structure.

LEGENDARY HANDLING

Our exclusive Hydra-Lift Hulls incorporate our Advanced Integrated Rib System (AIRS) that reinforces the hull's critical running surface when underway. Apart from providing smoother planing performance, Hydra-Lift improves handling in all water conditions for a more pleasing ride and better fuel economy.

HIGH AND DRY

Hydra-Lift Hulls raised eyebrows when they were first introduced, and they continue to lead the industry today with their smooth handling and dry ride. The combination of spray rails rolled into the side panels and Hydra-Lift's reverse-chine design beat down spray and keep water out of the boat – something you especially appreciate when heading out on those cold mornings early or late in the season.

ADVENTURER

GLS 188 SERIES 178 SERIES

MAXIMUM HP
90-250

LENGTH
17'11"-20'8"

BEAM
96"

Fishing isn't just something you do. It's part of who you are. Sound familiar? Then meet your new fishing buddy – Adventurer, by Smoker Craft. Fully loaded with pro features like twin FreshCatch livewells, a big raised bow casting deck, locking in-deck rod storage and a pro-style console with plenty of space for electronics, Adventurer is made to fish hard day after day – just like you. It plays hard too, which is why it comes in your choice of side console, dual console or fish-and-ski floorplans, in lengths from 17' to 18'.





ADVENTURER *fish without compromise*

FEATURING THE NEW **VPS** VERTEX PERFORMANCE STRAKE™ HULL

188 PRO DC
Shown with optional equipment.



CENTER ROD STORAGE
(FS MODELS ONLY)



188 DC
Shown with optional equipment.



C-ZONE DIGITAL WIRING SYSTEM

20 GLS
Shown with optional equipment.

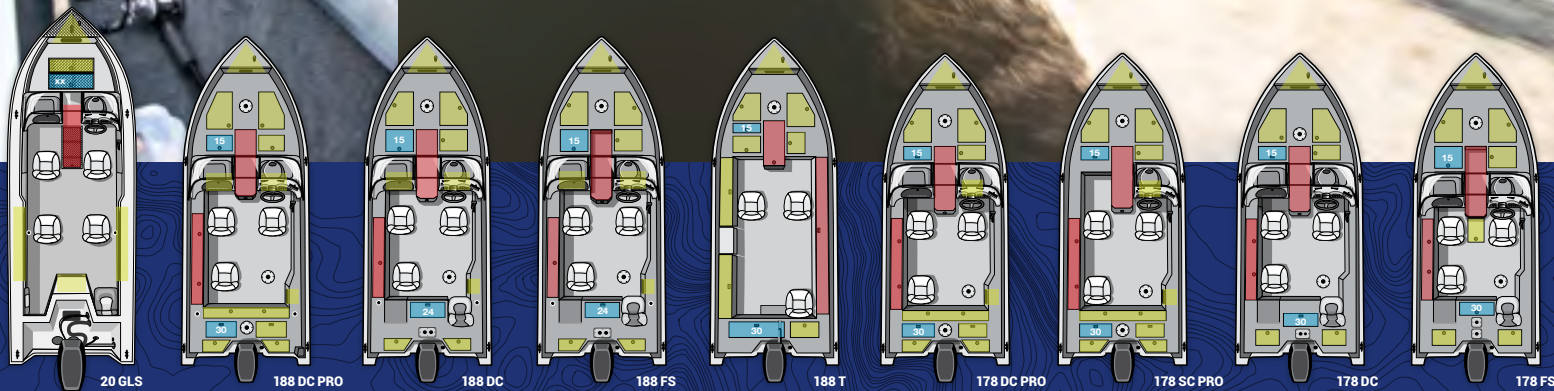

	Maximum HP	Fuel Capacity* (gal.)	Length	Beam	Dry Weight (lb)	Capacity (Persons/lb)	Seats	Interior Depth	Depth	Transom Height (Engine)	Bottom Gauge	Side Gauge	Deadrise at Transom
20 GLS	250	48	20'8"	102"	2080	7 / 1100	4	30"	41"	25"	.125"	.080"	19°
188 DC PRO	175	38	18'11"	96"	1792	6 / 850	3	23"	41"	25"	.125"	.080"	15°
188 DC	175	38	18'11"	96"	1792	6 / 850	3	23"	41"	25"	.125"	.080"	15°
188 FS	175	38	18'11"	96"	1792	6 / 850	3	23"	41"	25"	.125"	.080"	15°
188 T	90	38	18'11"	96"	1603	5 / 700	3	23"	41"	25"	.125"	.080"	15°
178 DC PRO	150	32	17'11"	96"	1731	6 / 825	3	22"	39"	25"	.125"	.080"	15°
178 SC PRO	150	32	17'11"	96"	1731	6 / 825	3	22"	39"	25"	.125"	.080"	15°
178 DC	150	32	17'11"	96"	1731	6 / 825	3	22"	39"	25"	.125"	.080"	15°
178 FS	150	32	17'11"	96"	1731	6 / 825	3	22"	39"	25"	.125"	.080"	15°

STANDARD FEATURES

- Heavy Gauge Aluminum Bottom
- Deluxe Wood-free Fishing Seats
- JENSEN AM / FM Stereo
- Lockable Center Rod Storage
- Integrated GUNNEL TRACK SYSTEM (IGTS)
- IGTS Mood Lighting
- Durable Vinyl Cockpits
- Aerated, Timed, Recirculating and Pump Out Stern Livewell
- Auto Bilge Pump
- Lockable Bow Storage
- Vertex Performance Strake™ (VPS) Hull
- Removable Baitwell Cooler (188T Only)
- Hydraulic Steering (Available on 188 Models)
- Xtreme™ Steering (Available on 178 Models)
- Bow Cushions (Available on FS Models)
- Lifetime +6 Warranty



POPULAR OPTIONS

- Sonar Unit
- 12/24 Trolling Motor
- Battery Charger
- Additional Fishing Seat
- Snap-on Mooring Cover
- Trailerable Ratchet Cover
- Fisherman's Top
- Full Enclosure (Available on DC Models)
- Depth Gauge
- Trim Gauge
- Ski Tow Pylon
- Swim Platform with 3-Step Ladder
- Removable Baitwell Cooler (178 Only)

COLOR OPTIONS



Silver Metallic + White + Red Accent



Silver Metallic + Blue



Silver Metallic + Black + Red Accent
(188 T only)



Silver Metallic + Black

Hydraulic steering is required for all 150HP and above.

* Smoker Craft uses diurnal EPA certified tanks which may hold less than listed content by approximately 10%.

To see more information on our fine Smoker Craft fishing boats, visit SMOKERCRAFT.COM.

Ultima

182 172

MAXIMUM HP
150-175

LENGTH
17'3"-18'2"

BEAM
96"

Is it the ultimate fishing boat for families or the ultimate family boat for anglers? Either way, Ultima is the budget-friendly family favorite with its convertible bow casting platform, flip-up jump seats in the stern and a handsomely upholstered cockpit interior that speaks to its tremendous versatility. Of course, there's lockable in-floor storage for both rods and skis, plus large bow and stern aerated livewells and even an available ski pylon.





Ultima *the ultimate in versatility*



182
Shown with optional Bert's
Custom Tackle Package, trolling
motor and sonar unit.



OPTIONAL 3-STEP BOARDING LADDER



172
Shown with optional equipment
and ski pylon.

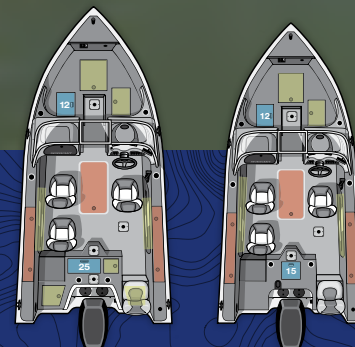

182

172

	Maximum HP	Fuel Capacity* (gal.)	Length	Beam	Dry Weight (lb)	Capacity (Persons/lb)	Seats	Interior Depth	Depth	Transom Width	Transom Height (Engine)	Bottom Gauge	Side Gauge	Rib Gauge	Deadrise at Transom
182	175	25	18'2"	96"	1425	8 / 1100	3	27"	41"	96"	25"	.125"	.080"	.125"	17°
172	150	20	17'3"	96"	1305	7 / 1000	3	25"	40"	88"	25"	.100"	.080"	.125"	17°

STANDARD FEATURES

- Convertible Walk-through Bow Casting Platform
- Lockable In-floor Rod Storage
- Convertible Ski Storage
- Port and Starboard Lockable, Top-loading Rod Storage
- Deluxe Console with Chrome-accented Gauges (Speedometer, Tachometer, Voltmeter and Fuel) and AM/FM Stereo with Speakers
- Xtreme™ Steering (172)
- Hydraulic Steering (182)
- Tilt Steering
- Aerated, Recirculating Livewells
 - (182) Bow: FreshCatch: 12-gallon
 - (182) Stern: FreshCatch Pro: 25-gallon
 - (172) Bow: FreshCatch: 12-gallon
 - (172) Stern: FreshCatch Pro: 15-gallon
- Integrated Gunnel Track System (IGTS)
- Vinyl Cockpits and Casting Decks
- EVA Soft Touch Traction Mat (Top Decks Only)
- Rear Flip-up Jump Seats
- Wood-free Deluxe Fishing Seats (up to Six Seat Bases)
- Durable .100-gauge (172) and .125-gauge (182) One-piece Hull
- Lifetime +6 Warranty



POPULAR OPTIONS

- All-weather Package (see page 48 for details)
- Power Package (see page 48 for details)
- Family Ski Package (includes ski pylon and 3-step boarding ladder)
- Trolling Motor with Quick Disconnect
- Sonar Unit
- LED Interior Lighting
- Battery Charger
- Yarblow Ventilation System
- Full Enclosure
- Fisherman's Top
- Mooring Cover
- Bow Cover
- Ski Pylon
- Additional Deluxe Fishing Seat
- 3-step Boarding Ladder
- Snap-in Carpet
- Depth Gauge
- Hydraulic Steering (standard on 182)
- Trailerable Ratchet Cover

COLOR OPTIONS



Silver Metallic + Blue

Silver Metallic + White

Hydraulic steering is required for all 150HP and above.

* Smoker Craft uses diurnal EPA certified tanks which may hold less than listed content by approximately 10%.

To see more information on our fine Smoker Craft fishing boats, visit SMOKERCRAFT.COM.

Ultima

LEGACY

the ultimate in versatility



172
Shown with optional fisherman's top,
3-step boarding ladder,
trolling motor and sonar unit.



DELUXE CONSOLE WITH OPTIONAL SONAR UNIT



172
Shown with optional fisherman's top,
3-step boarding ladder,
trolling motor and sonar unit.

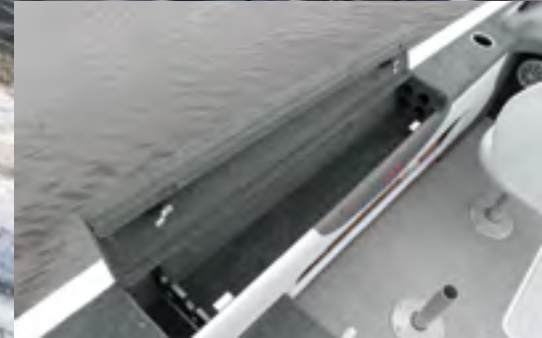

172
Shown with optional fisherman's top,
3-step boarding ladder,
trolling motor and sonar unit.



AERATED, RECIRCULATING LIVEWELL

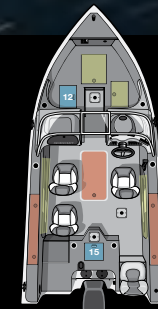

172
LEGACY

STANDARD FEATURES

- Convertible Walk-through Bow Casting Platform
- Lockable In-floor Rod Storage
- Convertible Ski Storage
- Port and Starboard Lockable, Top-loading Rod Storage
- LED Interior Lighting
- Deluxe Console with Chrome-accented Gauges (Speedometer, Tachometer, Voltmeter and Fuel) and AM/FM Stereo with Speakers
- Xtreme™ Steering
- Aerated, Recirculating Livewells
 - Bow: FreshCatch: 12-gallon
 - Stern: FreshCatch Pro: 15-gallon
- Vinyl Cockpits and Casting Decks
- Rear Flip-up Jump Seats
- Wood-free Deluxe Fishing Seats (up to Six Seat Bases)
- Bow Cushions
- Durable .100-gauge One-piece Hull
- Lifetime +6 Warranty



POPULAR OPTIONS

- All-weather Package (see page 48 for details)
- Power Package (see page 48 for details)
- Family Ski Package (includes ski pylon and 3-step boarding ladder)
- Trolling Motor with Quick Disconnect
- Sonar Unit
- Battery Charger
- Full Enclosure
- Fisherman's Top
- Mooring Cover
- Bow Cover
- Ski Pylon
- Additional Deluxe Fishing Seat
- 3-step Boarding Ladder
- Snap-in Carpet
- Hydraulic Steering
- Tilt Steering
- Trailerable Ratchet Cover

COLOR OPTIONS



Silver Metallic + Blue

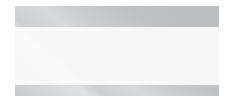

Silver Metallic + White

	Maximum HP	Fuel Capacity* (gal.)	Length	Beam	Dry Weight (lb)	Capacity (Persons/lb)	Seats	Interior Depth	Depth	Transom Width	Transom Height (Engine)	Bottom Gauge	Side Gauge	Rib Gauge	Deadrise at Transom
172 LEGACY	150	20	17'3"	96"	1305	7 / 1000	3	25"	40"	88"	25"	.100"	.080"	.125"	17°

Hydraulic steering is required for all 150HP and above.

* Smoker Craft uses diurnal EPA certified tanks which may hold less than listed content by approximately 10%.



SMOKER CRAFT

PRO ANGLER XL

182 XL 172 XL 171 XL 162 XL 161 XL

MAXIMUM HP
90-175

LENGTH
16'4"-18'2"

BEAM
92"-96"

Pro Angler XL leads its class with feature-packed value in a deep, beamy hull that provides more interior space. The large, elevated bow casting deck conceals deep storage lockers for bulky gear and still has space for a FreshCatch livewell, while the spacious main cockpit offers plenty of freeboard and the Integrated Gunnel Track System for mounting downriggers, rod holders and other accessories wherever they're needed. Lockable rod storage keeps expensive tackle safely out of sight when not in use, and its durable vinyl cockpit floor makes cleanup a snap.



PRO ANGLER XL

because size does matter



182 XL
Shown with optional Bert's Custom Tackle Package, trolling motor and sonar unit.

172 XL
Shown with optional Bert's Custom Tackle Package, trolling motor and sonar unit.

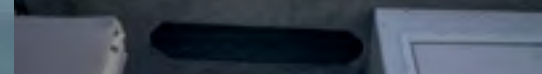
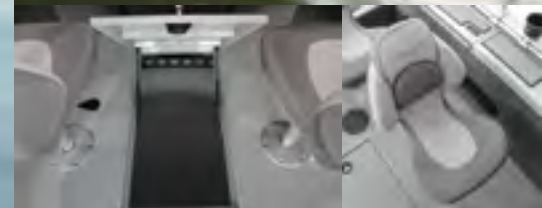

162 XL
Shown with optional trolling motor and sonar unit.



161 XL
Shown with optional Bert's Custom Tackle Package, trolling motor and sonar unit.



STANDARD FEATURES

- Automotive-style Console with Speedometer, Tachometer and Fuel Gauge and Lighted Rocker Switches
- Port and Starboard Lockable, Top-loading Rod Storage
- AM/FM Stereo (182 XL, 172 XL, 171 XL)
- Xtreme™ Steering
- Hydraulic Steering (182 XL)
- Extra-large Pro Capacity Recirculating Livewells
 - (182 XL) Bow: FreshCatch: 15-gallon
 - (182 XL) Stern: FreshCatch Pro: 25-gallon
 - (172 XL) Bow: FreshCatch: 15-gallon
 - (172 XL) Stern: FreshCatch Pro: 25-gallon
 - (162 XL) Bow: FreshCatch: 15-gallon
- Integrated Gunnel Track System (IGTS)
- Vinyl Cockpits
- EVA Soft Touch Traction Mat (Top Decks Only)
- Large Bow and Stern Casting Platforms
- Comfortable, Ergonomic Wood-free Fishing Seats (up to Six Seat Bases on 172 XL; up to Five Seat Bases on 162 XL, 161 XL)
- Durable .100-gauge (172 XL, 171 XL, 162 XL, 161 XL) and .125-gauge (182 XL) One-piece Hull
- Lifetime +6 Warranty



POPULAR OPTIONS

- All-weather Package (see page 48 for details)
- Power Package (see page 48 for details)
- Trolling Motor with Quick Disconnect
- Sonar Unit
- LED Interior Lighting
- Battery Charger
- Split Flip-up Bench Seat (N/A 161 XL)
- Additional Fishing Seat
- Yarblow Ventilation System
- Full Enclosure
- Mooring Cover
- Fisherman's Top
- Bow or Cockpit Cover
- 3-step Boarding Ladder
- Snap-in Carpet
- Depth Gauge
- AM/FM Stereo (162 XL, 161 XL)
- Hydraulic Steering (standard on 182 XL)
- Trailerable Ratchet Cover

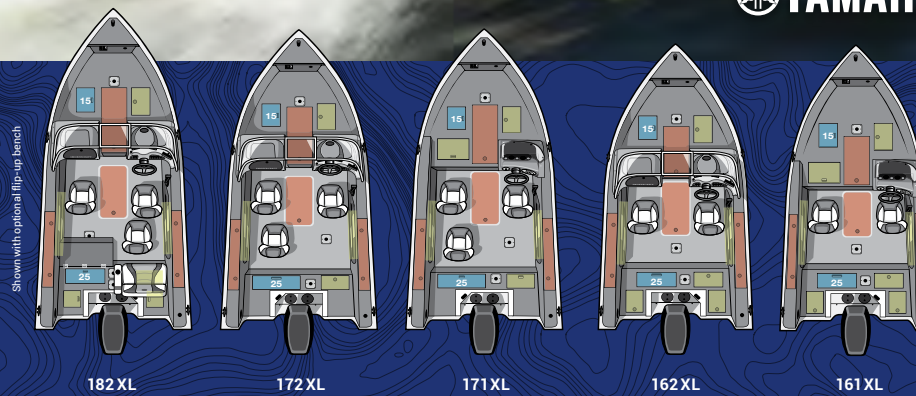

	Maximum HP	Fuel Capacity* (gal.)	Length	Beam	Dry Weight (lb)	Capacity (Persons/lb)	Seats	Interior Depth	Depth	Transom Width	Transom Height (Engine)	Bottom Gauge	Side Gauge	Rib Gauge	Deadrise at Transom
182 XL	175	25	18'2"	96"	1425	8 / 1100	3	27"	41"	96"	25"	.125"	.080"	.125"	17°
172 XL	150	20	17'3"	96"	1305	7 / 1000	3	25"	40"	88"	25"	.100"	.080"	.125"	17°
171 XL	150	20	17'3"	96"	1305	7 / 1000	3	25"	40"	88"	25"	.100"	.080"	.125"	17°
162 XL	90	20	16'4"	92"	1140	5 / 700	2	27"	37"	84"	20"	.100"	.070"	.125"	10°
161 XL	90	20	16'4"	92"	1140	5 / 700	2	27"	37"	88"	20"	.100"	.070"	.125"	10°

Hydraulic steering is required for all 150HP and above.

* Smoker Craft uses diurnal EPA certified tanks which may hold less than listed content by approximately 10%.

To see more information on our fine Smoker Craft fishing boats, visit SMOKERCRAFT.COM.

COLOR OPTIONS



Silver Metallic + Blue

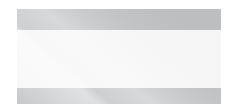

Silver Metallic + White

EXCURSION

17 PRO SERIES

17 SERIES

16 PRO SERIES

16 SERIES

MAXIMUM HP
70-115

LENGTH
16'5"-17'8"

BEAM
88"

Excursion takes the best of our top-of-the-line models and packs it into a more compact footprint that is easy to trailer and even easier to afford. Excursion offers pro-level features like a deep cockpit, plenty of free board, a huge raised bow deck and ample rod storage. Plus, it is built on Smoker Craft's Vertex Performance Strake™ Hull for superior performance.

FEATURING C-ZONE DIGITAL WIRING SYSTEM

Simplify your boat's operation system with C-Zone digital wiring. C-Zone, standard on all Excursion series boats, gives you complete control of all electrical functions with the touch of a button. From monitoring pump levels, battery levels and other critical functions, to optimizing the onboard environment via a multi-circuit switch, you can take your boat to the next level of performance and sophistication when you let C-Zone do the thinking.

SYSTEM FEATURES:

Clean Dash

- Dash-mounted Waterproof switch Pad
- Can be Integrated with MFD

Simple Installation and Maintenance

Integrated Circuit Protection

Complete Control

- Navigation Lights
- LED Lights
- Stereo System





EXCURSION PRO *unlimited possibilities*

FEATURING THE NEW **VPS** VERTEX PERFORMANCE STRAKE™ HULL

17 DC PRO
Shown with optional trolling motor and sonar unit.



17 DC PRO
Shown with optional trolling motor and sonar unit.

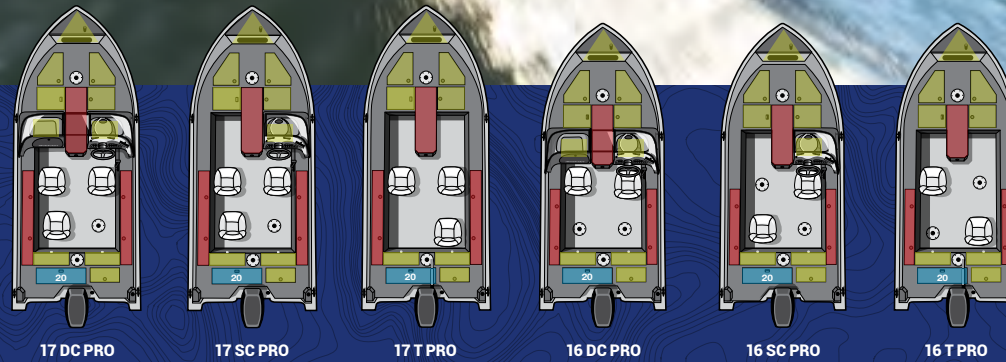

STANDARD FEATURES

- 7-ply Pressure Treated Floor and Deck
- Pro Style Wood-free Fishing Seats
- 20-gallon Aerated Livewell
- Under Console Storage
- Aft Pro Deck Storage Compartment
- Center Rod Storage for 7' Rods
- Port and Starboard Top-loading Storage for 8' Rods
- Xtreme™ Steering
- Fuel, Speed, Tach and Volt Gauges
- Integrated Gunnel Track System (IGTS)
- Vertex Performance Strake™ (VPS) Hull
- C-Zone Digital Wiring System
- Lifetime +6 Warranty



POPULAR OPTIONS

- Sonar Unit
- SeaStar™ Hydraulic Steering
- 12/24V Trolling Motor
- 3-bank Battery Charger
- Additional Pro Style Wood-free Fishing Seat
- Snap-on Mooring Cover
- Full Enclosure with Bow Cover (Side, Aft, Walk-through Curtains; Requires Fisherman's Top)
- Fisherman's Top
- Depth Gauge
- Trim Gauge
- Power Pedestal
- JENSEN Stereo with Bluetooth®
- Swim Platform with Stainless 3-step Boarding Ladder
- Bert's Custom Tackle Packages (see page 48 for details)

COLOR OPTIONS



Sapphire Blue



Silver Metallic

	Maximum HP	Fuel Capacity* (gal.)	Length	Beam	Dry Weight (lb)	Capacity (Persons/lb)	Seats	Interior Depth	Depth	Transom Height (Engine)	Bottom Gauge	Side Gauge	Deadrise at Transom
17 DC PRO	115	24	17'8"	88"	1183	5 / 700	3	23"	34"	20"	.100"	.070"	12°
17 SC PRO	115	24	17'8"	88"	1111	5 / 700	3	23"	34"	20"	.100"	.070"	12°
17 T PRO	75	24	17'8"	88"	1051	5 / 700	3	23"	34"	20"	.100"	.070"	12°
16 DC PRO	90	24	16'5"	88"	1094	5 / 610	2	22"	34"	20"	.080"	.060"	12°
16 SC PRO	90	24	16'5"	88"	1022	5 / 610	2	22"	34"	20"	.080"	.060"	12°
16 T PRO	70	24	16'5"	88"	962	5 / 610	2	22"	34"	20"	.080"	.060"	12°

EXCURSION *maximum fishability*

FEATURING THE NEW **VPS** VERTEX PERFORMANCE STRAKE™ HULL

17 DC
Shown with optional equipment.





16 T
Shown with optional trolling motor and flush-mounted sonar unit.

STANDARD FEATURES

- 7-ply Pressure Treated Floor and Deck
- Pro Style Wood-free Fishing Seats
- 20-gallon Aerated Livewell
- Under Console Storage
- Port and Starboard Top-loading Storage for 8' Rods
- Xtreme™ Steering
- Fuel, Speed, Tach and Volt Gauges
- Integrated Gunnel Track System (IGTS)
- Vertex Performance Strake™ (VPS) Hull
- C-Zone Digital Wiring System
- Lifetime +6 Warranty



POPULAR OPTIONS

- Sonar Unit
- SeaStar™ Hydraulic Steering
- 12/24V Trolling Motor
- 3-bank Battery Charger
- Additional Pro Style Wood-free Fishing Seat
- Snap-on Mooring Cover
- Full Enclosure with Bow Cover (Side, Aft, Walk-through Curtains; Requires Fisherman's Top)
- Fisherman's Top
- Depth Gauge
- Trim Gauge
- Power Pedestal
- JENSEN Stereo with Bluetooth®
- Swim Platform with Stainless 3-step Boarding Ladder
- Bert's Custom Tackle Packages (see page 48 for details)

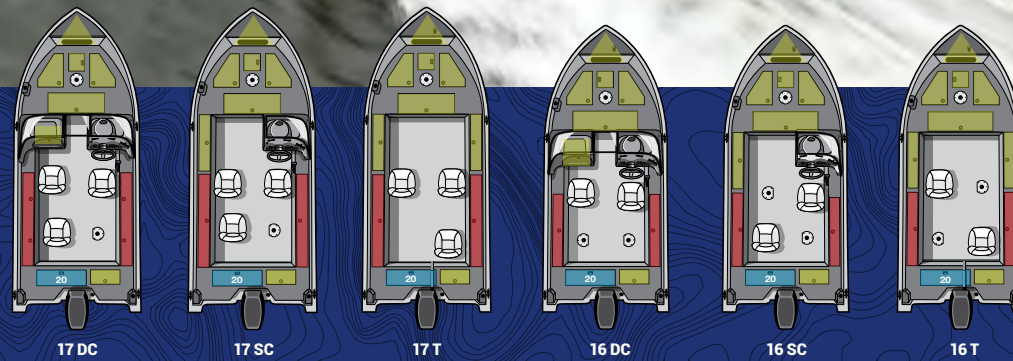

	Maximum HP	Fuel Capacity* (gal.)	Length	Beam	Dry Weight (lb)	Capacity (Persons/lb)	Seats	Interior Depth	Depth	Transom Height (Engine)	Bottom Gauge	Side Gauge	Deadrise at Transom
17 DC	115	24	17'8"	88"	1183	5 / 700	3	23"	34"	20"	.100"	.070"	12°
17 SC	115	24	17'8"	88"	1111	5 / 700	3	23"	34"	20"	.100"	.070"	12°
17 T	75	24	17'8"	88"	1051	5 / 700	3	23"	34"	20"	.100"	.070"	12°
16 DC	90	24	16'5"	88"	1094	5 / 610	2	22"	34"	20"	.080"	.060"	12°
16 SC	90	24	16'5"	88"	1022	5 / 610	2	22"	34"	20"	.080"	.060"	12°
16 T	70	24	16'5"	88"	962	5 / 610	2	22"	34"	20"	.080"	.060"	12°

COLOR OPTIONS



Sapphire Blue



Silver Metallic



PRO ANGLER

172 162 161

MAXIMUM HP
60-140

LENGTH
16'2"-16'10"

BEAM
81"-92"

You cast for bass in the morning, troll for muskie at mid-day then jig for walleyes before heading in. Multi-species anglers need a versatile boat, and Pro Angler delivers. We're talking oversized, raised bow and stern casting platforms, a massive 25-gallon FreshCatch aerated livewell, lockable rod storage and an automotive-style console with full gauges and plenty of space for electronics. With its wood-free fishing seats and a heavy gauge .100" one-piece bottom, this is one fishing buddy that's in it for the long haul.



PRO ANGLER *the multi-species champion*



172
Shown with optional trolling motor
and sonar unit.



OPTIONAL REAR FLIP-UP BENCH SEAT (172)



161
Shown with optional trolling motor and sonar unit.

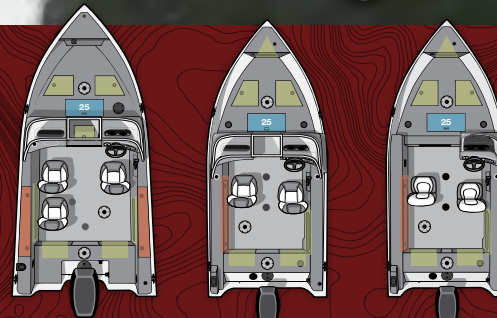

172

162

161

	Maximum HP	Fuel Capacity* (gal.)	Length	Beam	Dry Weight (lb)	Capacity (Persons/lb)	Seats	Interior Depth	Depth	Transom Width	Transom Height (Engine)	Bottom Gauge	Side Gauge	Rib Gauge	Deadrise at Transom
172	140	20	16'10"	92"	1225	5 / 675	3	24"	34"	91"	TL	.100"	.080"	.100"	14°
162	60	15	16'2"	81"	845	5 / 680	2	25"	33"	74"	TL	.100"	.070"	.100"	10°
161	60	15	16'2"	81"	845	5 / 680	2	25"	33"	74"	TL	.100"	.070"	.100"	10°

STANDARD FEATURES

- Automotive-style Console with Speedometer, Tachometer and Fuel Gauge and Lighted Rocker Switches
- Port and Starboard Lockable, Top-loading Rod Storage
- FreshCatch 25-gallon Livewell
- Wood-free Fishing Seats (up to Six Seat Bases on 172; up to Five Seat Bases on 162, 161)
- Vinyl Cockpits
- Large Bow and Stern Casting Platforms with 18-oz. Carpet
- Durable .100-gauge One-piece Hull
- Lifetime +6 Warranty



POPULAR OPTIONS

- All-weather Package (see page 48 for details)
- Power Package (see page 48 for details)
- Trolling Motor with Quick Disconnect
- Sonar Unit
- Battery Charger
- Split Flip-up Bench Seat (N/A 161)
- Additional Fishing Seat
- Full Enclosure
- Mooring Cover
- Fisherman's Top
- Bow or Cockpit Cover
- 3-step Boarding Ladder
- Snap-in Carpet
- Depth Gauge
- AM/FM Stereo
- Hydraulic Steering
- Xtreme™ Steering
- No Feedback Tilt Steering

COLOR OPTIONS

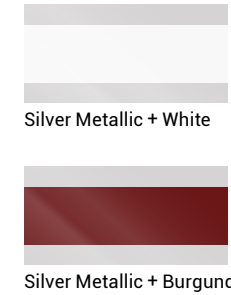

Silver Metallic + White

Silver Metallic + Burgundy

ANGLER

STANDARD FEATURES

- 7-ply Pressure Treated Floor and Deck
- Two Wood-free Fishing Seats
- Durable Vinyl Cockpits and Casting Platforms
- Lockable Rod Storage
- Lifetime +6 Warranty



POPULAR OPTIONS

- Humminbird® HELIX 5 GPS with Ram Mount
- Trolling Motor
- Snap-on Mooring Cover
- Additional Fishing Seat
- Power Pedestal
- Seat Slider

COLOR OPTION

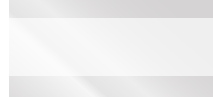

White

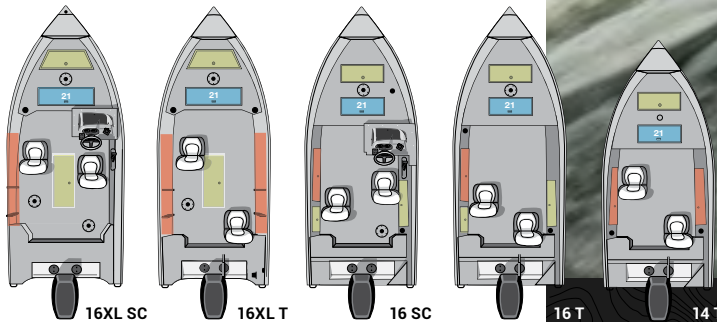

16 SC
Shown with optional trolling motor.



FRESHCATCH 25-GALLON LIVEWELL



16 T

	Maximum HP	Fuel Capacity* (gal.)	Length	Beam	Dry Weight (lb)	Capacity (Persons/lb)	Seats	Interior Depth	Depth	Transom Ht. (Engine)	Bottom Gauge	Side Gauge	Deadrise at Transom
16XL SC	60	PORTABLE TANK	16'2"	81"	845	5 / 680	2	25"	33"	20"	.080"	.070"	7°
16XL T	40	PORTABLE TANK	16'2"	81"	845	5 / 680	2	25"	33"	20"	.080"	.070"	7°
16 SC	60	PORTABLE TANK	16'4"	78"	685	5 / 670	2	20.5"	23"	20"	.080"	.060"	7°
16 T	40	PORTABLE TANK	16'4"	78"	625	5 / 670	2	20.5"	23"	20"	.080"	.060"	7°
14 T	40	PORTABLE TANK	14'8"	77"	540	4 / 555	2	20.5"	23"	20"	.080"	.060"	7°

Resorter

STANDARD FEATURES

- Automotive-style Console with Speedometer, Tachometer and Lighted Rocker Switches
- FreshCatch 18-gallon Center Bow Livewell
- Two Wood-free Fishing Seats (up to Six Seat Bases)
- Large Dry Bow Storage and Side-mounted Rod Holders
- Large Bow and Stern Casting Platforms with 18 Oz. Carpet
- Vinyl Cockpit for Easy Cleanup and Durability
- Heavy Gauge .100" Aluminum One-piece Bottom
- Lifetime +6 Warranty



POPULAR OPTIONS

- Power Package (see page 48 for details)
- Trolling Motor with Quick Disconnect
- Battery Charger
- Additional Fishing Seat
- 2-step Boarding Ladder
- Mooring Cover
- Depth Finder

COLOR OPTIONS



Black



Silver Metallic + Burgundy

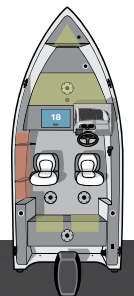

151
Shown with optional trolling motor and sonar unit.



LIVEWELL



BOW CASTING PLATFORM



DRIVER'S CONSOLE
Shown with optional sonar unit



	Maximum HP	Fuel Capacity* (gal.)	Length	Beam	Dry Weight (lb)	Capacity (Persons/lb)	Seats	Interior Depth	Depth	Transom Width	Transom Ht. (Engine)	Bottom Gauge	Side Gauge	Rib Gauge	Deadrise at Transom
151	50	PORTABLE TANK	15'2"	75"	675	4 / 580	2	23"	30"	73"	TL	.100"	.064"	.064"	5°

* Smoker Craft uses diurnal EPA certified tanks which may hold less than listed content by approximately 10%.

NORTH AMERICAN ANGLER

WHEN IT'S TIME TO BRING YOUR "A" GAME.

No matter where you love to fish, the American Angler Series by Smoker Craft is up to the challenge. Big water? Rough weather? These all-welded hulls are ready for anything with their exclusive Torsion Beam Construction built for exceptional strength and shock absorption — plus the peace of mind of a lifetime warranty.





THE INDUSTRY'S BEST WARRANTY. PERIOD.

Only a company with the proven history and longevity of a brand like American Angler by Smoker Craft can offer something like this:

- Limited lifetime warranty on hull and structure
- 6-year warranty on all components, carpet, upholstery and electronics
- All parts and labor
- Transferable to second owner

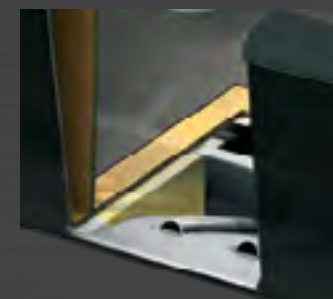

TWICE-BAKED PAINTED HULLS

American Angler full painted hulls provide showroom looks designed to last for years.

MACHINE FORMED RIBS*

Our unique machine formed ribs are stronger and more flexible than the two-ply aluminum used by many competitors.

TORSION BEAM CONSTRUCTION*

Instead of the flat I-Beams that you find in many boats, American Angler uses our exclusive Torsion Beam Construction (TBC) stringer system for exceptional strength and shock absorption.

ALL-WELDED CONSTRUCTION

Every American Angler series boat offers the toughness and reliability of all-welded marine-grade aluminum construction that's backed by a lifetime warranty.

INJECTED FOAM FLOTATION

American Angler models feature injected foam, not poured, between the floor and hull – filling all air pockets. This provides greater strength and buoyancy and reduces noise.

* Pro Lodge, Pro Tracer and Osprey series

Phantom *where big water meets its match*



20 X2
Shown with optional equipment and
Bert's Custom Tackle Package.



20 X2 OS
Shown with optional equipment and
Bert's Custom Tackle Package.



DRIVER'S CONSOLE



WALK THROUGH WINDSHIELD



OPTIONAL SIDE JUMP SEATS



OPEN ROD STORAGE AND INTEGRATED
GUNNEL TRACK SYSTEM WITH OPTIONAL
BERT'S CUSTOM TACKLE ACCESSORIES



DUAL CONSOLE AND IN-FLOOR ROD STORAGE

STANDARD FEATURES

- Treated Floor with Lifetime Warranty
- Full Vinyl Floor
- Elevated Console
- Tachometer, Speed, Volt and Fuel Gauges
- Under Console Storage
- Open Rod Storage
- Tackle Tray
- Toe Holds
- Hydraulic Steering
- Integrated Gunnel Track System (IGTS)
- Coaming Gunnel with Watershed Channel
- Bow Fish Box
- Wash Down Kit
- Navigation Lights
- Dual Auto Bilge Pumps



18 X2
Shown with optional equipment
and Bert's Custom Tackle.



POPULAR OPTIONS

- Bow Mount Anchor Release
- Bow Rails
- Stern Rails
- Wiper
- Fisherman's Top with Side, Walk Through and Drop Curtains
- Rigid Frame Soft Top
- Jump Seats with Storage Box
- Fish Package
- Fuel Water Separator
- Trolling Motor Plug
- Additional Seat

COLOR OPTIONS



White

Black

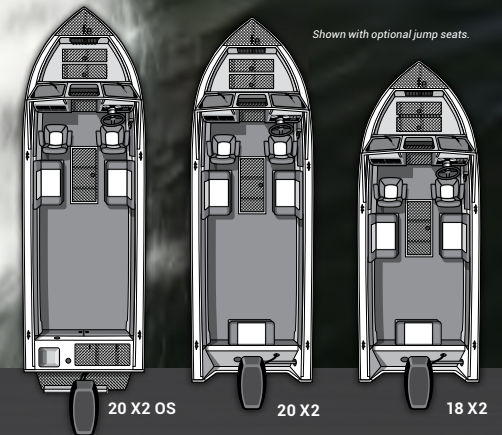

Shown with optional jump seats.



	Maximum HP	Fuel Capacity* (gal.)	Length	Beam	Dry Weight (lb)	Capacity (Persons/ lb)	Seats	Interior Depth	Depth	Transom Width	Transom Height (Engine)	Bottom Gauge	Side Gauge	Deadrise at Transom
20 X2 OS	250	52	20'5"	98"	1625	6 / 800	2	33"	47"	96"	25"	.160"	.125"	19°
20 X2	200	52	20'5"	98"	1778	6 / 800	2	33"	47"	96"	25"	.160"	.125"	19°
18 X2	150	32	18'6"	96"	1680	6 / 850	2	33"	45"	96"	25"	.160"	.125"	15°

Hydraulic steering is required for all 150HP and above.

* Smoker Craft uses diurnal EPA certified tanks which may hold less than listed content by approximately 10%.

Osprey

the sporty side of serious fishing



**HONDA
MARINE**

172
Shown with optional side jump seats.



OSPREY 172



STORAGE BOX

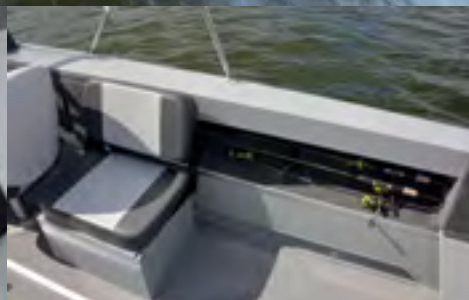

OPTIONAL SIDE JUMP SEAT AND OPEN ROD STORAGE



FULL VINYL COCKPIT AND CASTING DECK



BOW LIVEWELL

STANDARD FEATURES

- Treated Floor with Lifetime Warranty
- Full Vinyl Floor
- Elevated Console
- Tachometer, Speed, Volt and Fuel Gauges
- Under Console Storage
- Open Rod Storage
- Tackle Tray
- Toe Holds
- Tilt Steering
- In-floor Fish Box
- Fisherman's Top with Side, Walk Through and Drop Curtains
- 25 Gallon Bow Livewell
- Navigation Lights
- Bilge Pump



POPULAR OPTIONS

- Side Jump Seats
- Bow Mount Anchor Release
- Bow Rails
- Additional Fishing Seat
- Hydraulic Steering
- Trolling Motor Plug

COLOR OPTION



White



HONDA
MARINE

162
Shown with optional side jump seats.

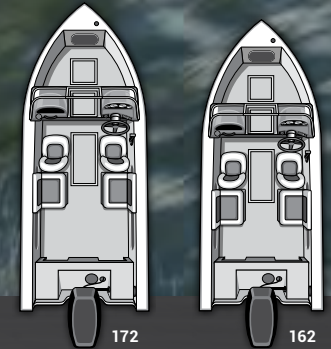

172

162

162

Shown with optional side jump seats.



	Maximum HP	Fuel Capacity* (gal.)	Length	Beam	Dry Weight (lb)	Capacity (Persons/lb)	Seats	Interior Depth	Depth	Transom Width	Transom Height (Engine)	Bottom Gauge	Side Gauge	Deadrise at Transom
172	150	25	17'4"	90"	1165	6 / 850	2	27"	41"	90"	20"	.100"	.100"	17°
162	115	20	16'4"	90"	1075	6 / 765	2	27"	39"	90"	20"	.100"	.100"	17°

Hydraulic steering is required for all 150HP and above.

* Smoker Craft uses diurnal EPA certified tanks which may hold less than listed content by approximately 10%.

Pro Tracer *lighten up for easier towing*

STANDARD FEATURES

- Treated Floor with Lifetime Warranty
- Full Vinyl Floor
- Elevated Console
- Fuel Gauge
- Under Console Storage
- Bow Storage
- Open Rod Storage
- Tackle Tray
- Toe Holds
- 25 Gallon Bow Livewell
- Bow Rail
- Navigation Lights
- Bilge Pump
- Fisherman's Top with Side, Walk Through and Drop Curtains



POPULAR OPTIONS

- Trolling Motor Plug
- Four Cleats
- Downrigger Brackets
- Bow Mount Anchor Release
- Side Jump Seats
- Additional Fishing Seat

COLOR OPTION

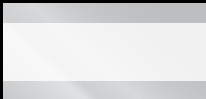

White

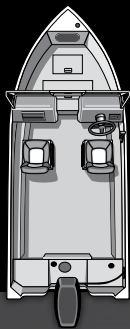

HONDA
MARINE

162
Shown with optional side jump seats.



PASSENGER CONSOLE



DRIVER'S CONSOLE

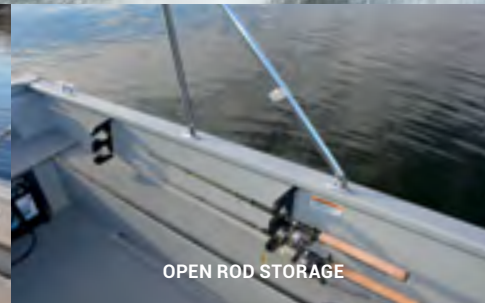

OPEN ROD STORAGE



OPTIONAL SIDE-BY-SIDE JUMP SEATS

	Maximum HP	Fuel Capacity* (gal.)	Length	Beam	Dry Weight (lb)	Capacity (Persons/ lb)	Seats	Interior Depth	Depth	Transom Width	Transom Height (Engine)	Bottom Gauge	Side Gauge	Deadrise at Transom
162	90	12	16'6"	82"	1025	6 / 815	2	24"	37"	79"	20"	.100"	.100"	10°



open for adventure **Pro Lodge**



162
Shown with optional trolling motor and sonar unit.

STANDARD FEATURES

- Treated Floor with Lifetime Warranty
- Full Vinyl Floor
- Open Rod Storage
- Tackle Tray
- Toe Holds
- Bow Storage
- 25 Gallon Bow Livewell
- Dual Storage Boxes with Swivel Seats
- Pedestal Driver's Seat
- Navigation Lights
- Bilge Pump



POPULAR OPTIONS

- Side Console
- Two Downrigger Brackets
- Bow Mount Anchor Release
- Bow Rails
- Additional Fishing Seat
- Trolling Motor Plug

COLOR OPTION

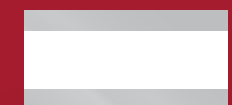

White

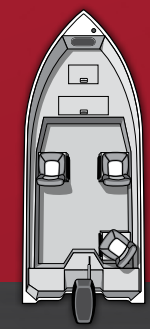

OPTIONAL SIDE CONSOLE



EXTRA-WIDE INTERIOR

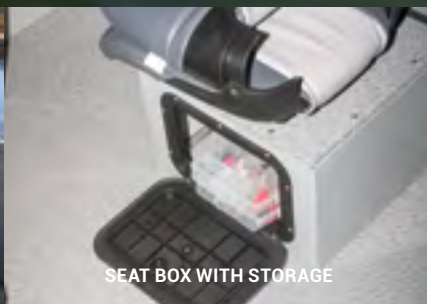

SEAT BOX WITH STORAGE



	Maximum HP	Fuel Capacity* (gal.)	Length	Beam	Dry Weight (lb)	Capacity (Persons/lb)	Seats	Interior Depth	Depth	Transom Width	Transom Height (Engine)	Bottom Gauge	Side Gauge	Deadrise at Transom
160	60	12	16'6"	82"	995	6 / 815	2	24"	37"	79"	20"	.100"	.100"	10°

* Smoker Craft uses diurnal EPA certified tanks which may hold less than listed content by approximately 10%.

Pro Sportsman

STANDARD FEATURES

- Treated Floor with Lifetime Warranty
- Full Vinyl Floor
- Fuel Gauge
- Bow Storage
- Open Rod Storage
- Tackle Tray
- Toe Holds
- 25 Gallon Bow Livewell
- Upgraded Graphics



POPULAR OPTIONS

- Trolling Motor Plug
- Four Cleats
- Downrigger Brackets
- Bow Mount Anchor Release
- Additional Fishing Seats
- Seat Box with Storage
- Bow Livewell

COLOR OPTIONS

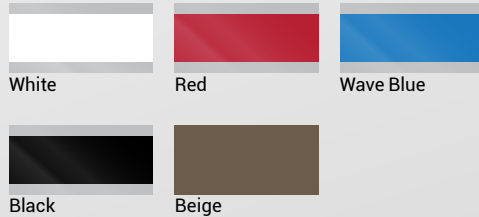

2072 T



2072 CC
Shown with optional center console.

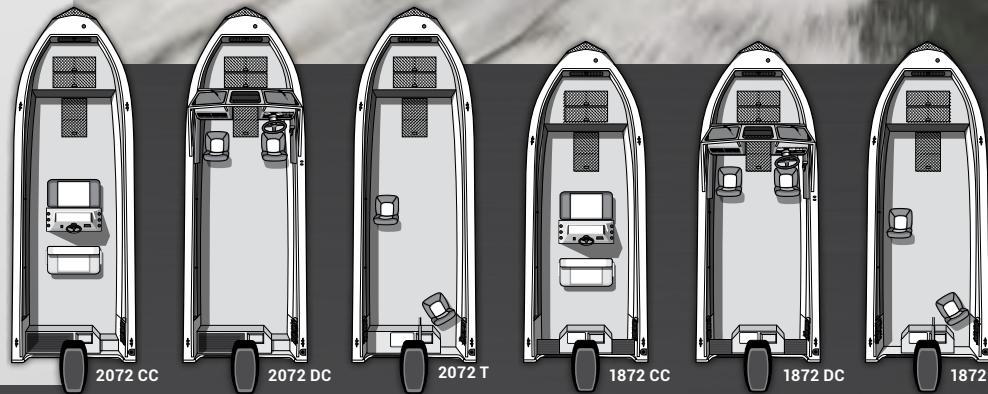

CENTER CONSOLE BENCH

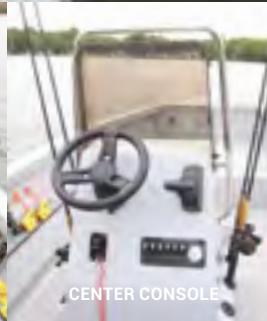

CENTER CONSOLE



1872 T

	Maximum HP	Fuel Capacity* (gal.)	Length	Beam	Dry Weight (lb)	Capacity (Persons/lb)	Seats	Interior Depth	Depth	Transom Width	Transom Height (Engine)	Bottom Gauge	Side Gauge	Deadrise at Transom
2072 CC	175	33	20'6"	99"	1778	6 / 850	2	27"	33.5"	92"	25"	.160"	.125"	10°
2072 DC	175	33	20'6"	99"	1778	6 / 850	2	27"	33.5"	92"	25"	.160"	.125"	10°
2072 T	150	33	20'6"	99"	1620	6 / 850	2	27"	33.5"	92"	25"	.160"	.125"	10°
1872 CC	140	33	18'6"	99"	1726	6 / 800	2	27"	33.5"	92"	25"	.160"	.125"	14°
1872 DC	140	33	18'6"	99"	1726	6 / 800	2	27"	33.5"	92"	25"	.160"	.125"	14°
1872 T	90	33	18'6"	99"	1595	6 / 800	2	27"	33.5"	92"	25"	.160"	.125"	14°

Sportsman



STANDARD FEATURES

- Treated Floor with Lifetime Warranty
- Full Vinyl Floor
- Fuel Gauge
- Bow Storage
- Open Rod Storage
- Tackle Tray
- Toe Holds



POPULAR OPTIONS

- High-Back Seat with Swivel
- Seat Box with Storage
- Center Console
- Side Console
- Windscreen
- Trolling Motor Plug
- Four Cleats
- Bow Rails
- Stern Rails
- Downrigger Brackets
- Bow Mount Anchor Release
- Additional Fishing Seats

COLOR OPTIONS



Beige

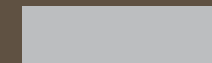

Gray

1866 PRO

Shown with optional side console, fishing seat and stern rails.



SEAT BOX WITH STORAGE



SIDE CONSOLE (1866, 1660)



OPTIONAL CENTER CONSOLE

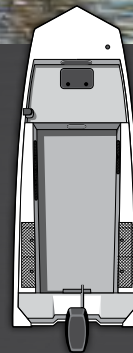

1866 PRO

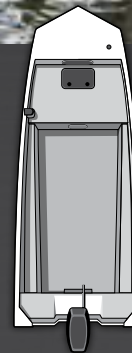

1866

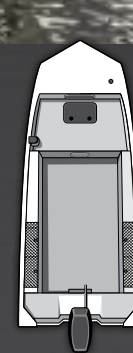

1660 PRO

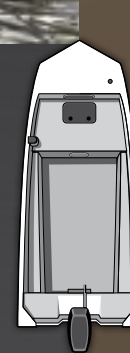

1660



	Maximum HP	Fuel Capacity* (gal.)	Length	Beam	Dry Weight (lb)	Capacity (Persons/lb)	Interior Depth	Depth	Transom Width	Transom Height (Engine)	Bottom Gauge	Side Gauge	Deadrise at Transom
1866 PRO	90	28	18'7"	92"	955	6 / 825	26"	29"	92"	20"	.100"	.100"	10°
1866	90	28	18'7"	92"	900	6 / 825	26"	29"	92"	20"	.100"	.100"	10°
1660 PRO	70	17	16'7"	86"	870	6 / 800	23"	26"	88"	20"	.100"	.100"	10°
1660	70	17	16'7"	86"	840	6 / 800	23"	26"	88"	20"	.100"	.100"	10°

* Smoker Craft uses diurnal EPA certified tanks which may hold less than listed content by approximately 10%.

FREEDOM

STANDARD FEATURES

- 7-ply Pressure Treated Floor and Deck
- Two Wood-free Fishing Seats
- Durable Vinyl Cockpits and Casting Platforms
- Port Livewell
- Lifetime +6 Warranty



POPULAR OPTIONS

- Trolling Motor
- Snap-on Mooring Cover
- Additional Fishing Seat
- Power Pedestal
- Seat Slider

COLOR OPTIONS



Black



Beige

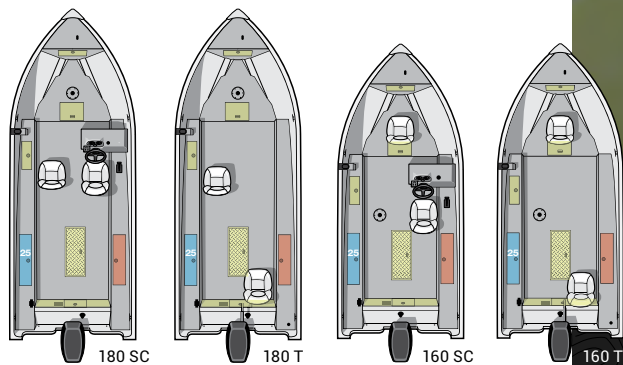

180 SC
Shown with optional trolling motor.



WOOD-FREE FISHING SEAT



DELUXE CONSOLE (160 SC)



FRESHCATCH 25-GALLON LIVEWELL



160 T
Shown with optional trolling motor and sonar unit.

	Maximum HP	Fuel Capacity* (gal.)	Length	Beam	Dry Weight (lb)	Capacity (Persons/lb)	Seats	Interior Depth	Depth	Transom Width	Transom Ht. (Engine)	Bottom Gauge	Side Gauge	Deadrise at Transom
180 SC	125	17	18'10"	89"	1055	6 / 900	2	22"	35"	85"	20"	.100"	.080"	10°
180 T	90	17	18'10"	89"	1005	6 / 900	2	22"	35"	85"	20"	.100"	.080"	10°
160 SC	90	17	16'10"	89"	975	6 / 900	2	22"	35"	85"	20"	.100"	.080"	10°
160 T	75	17	16'10"	89"	925	6 / 900	2	22"	35"	85"	20"	.100"	.080"	10°

Utilities

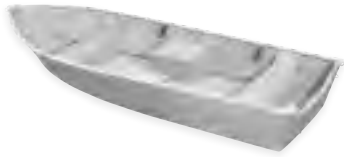

15' ALASKAN TS/TL
SPLIT SEAT DLX



13' ALASKAN TS/TL
SPLIT SEAT DLX



16' VOYAGER



14' VOYAGER



14' CANADIAN



12' CANADIAN

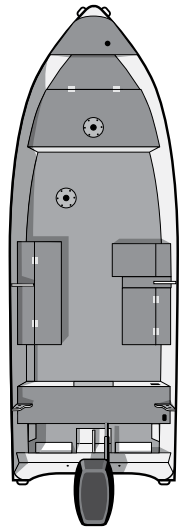

16' BIG FISHERMAN

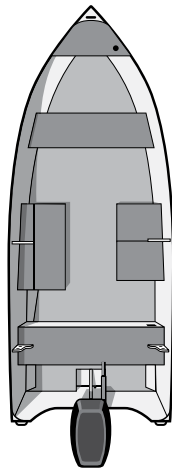

14' BIG FISHERMAN

	Maximum HP	Fuel Capacity (gal.)	Overall Length	Beam	Depth	Interior Depth	Transom Width	Transom Height (Engine)	Dry Weight (lb)	Maximum Persons	Maximum Capacity (lb)	Color	Bottom Gauge	Side Gauge	Rib Gauge
16' BIG FISHERMAN	30	N/A	16'5"	70"	31"	22"	63"	TL	460	5	965	Black	.070"	.060"	.064"
14' BIG FISHERMAN	30	N/A	14'2"	68"	30"	22"	60"	TL / TS	395	4	825	Black	.070"	.060"	.064"
15' ALASKAN TL SPLIT SEAT DLX	35	N/A	14'11"	68"	27"	21"	59"	TL	270	4	850	Gray	.070"	.060"	.064"
15' ALASKAN TS SPLIT SEAT DLX	35	N/A	14'11"	68"	27"	21"	59"	TS	270	4	850	Gray	.070"	.060"	.064"
13' ALASKAN TL SPLIT SEAT DLX	20	N/A	12'11"	66"	26"	20"	56"	TL	225	3	625	Gray	.064"	.060"	.064"
13' ALASKAN TS SPLIT SEAT DLX	20	N/A	12'11"	66"	26"	20"	56"	TS	225	3	625	Gray	.064"	.060"	.064"
16' VOYAGER	30	N/A	16'2"	68"	29"	20"	56"	TL	290	5	965	Black	.100"	.060"	.064"
14' VOYAGER	30	N/A	14'2"	68"	30"	30"	60"	TL / TS	230	4	825	Black	.070"	.060"	.064"
14' VOYAGER SPLIT SEAT	35	N/A	14'2"	68"	30"	30"	60"	TL / TS	230	4	1000	Black	.070"	.060"	.064"
14' CANADIAN	15	N/A	13'10"	59"	20"	20"	50"	TS	130	4	700	White	.050"	.050"	.050"
12' CANADIAN	10	N/A	11'9"	56"	20"	20"	50"	TS	112	3	600	White	.050"	.050"	.050"

COLORS (Not all color options available for all models)

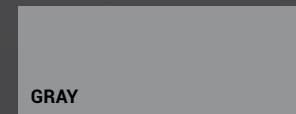

FEATURES AND OPTIONS

Personalize and optimize your Smoker Craft and North American Angler

Talk with your dealer about these available performance upgrade packages.



POWER PACKAGE

Includes Trolling Motor with Quick Disconnect, Sonar Unit and Power Prep – Factory-Rigged Motor and Accessories.



ALL-WEATHER PACKAGE

Includes Mooring Cover, Snap-in Carpet and Fisherman's Top.



PREMIUM STEERING PACKAGE

Ask your dealer how you may optimize your boat's performance with premium steering options.



BERT'S CUSTOM TACKLE PACKAGES

Crafted to accommodate your personal angling gear, these tackle packages keep equipment in its place.

Smoker Craft Interior



DRIVER'S CONSOLE



OPTIONAL FLUSH-MOUNT SONAR UNIT



OPTIONAL DEPTH GAUGE



OPTIONAL SNAP-IN CARPET

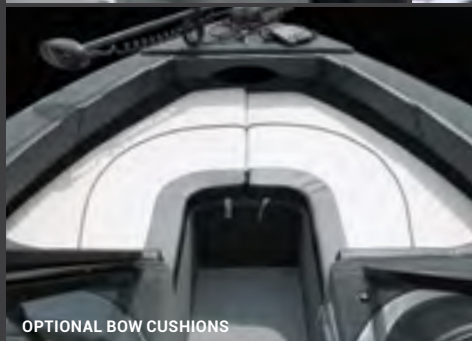

OPTIONAL BOW CUSHIONS



OPTIONAL FLIP-UP JUMP SEAT



DELUXE FISHING SEAT



OPTIONAL ON BOARD BATTERY CHARGER

Smoker Craft Sound

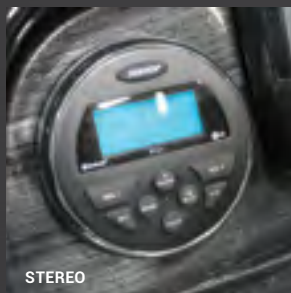

STEREO



AUDIO SPEAKERS

C-Zone Digital System



Smoker Craft Tops and Enclosures



OPTIONAL FULL ENCLOSURE

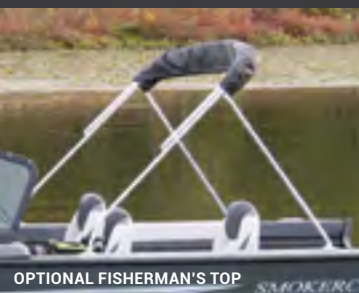

OPTIONAL FISHERMAN'S TOP



OPTIONAL MOORING COVER

with a wide range of features and options.

North American Angler Interior



Smoker Craft Exterior



North American Angler Exterior

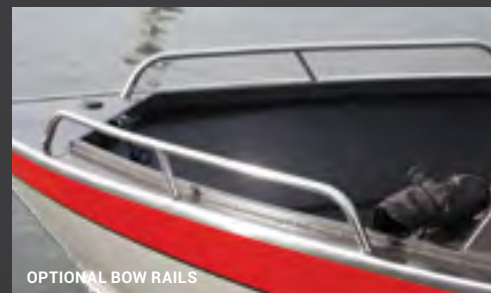

Smoker Craft Livewell Options

From evening dinner to that coveted trophy fish, Smoker Craft's FreshCatch aerated livewells keep every catch safe and fresh.

FRESHCATCH

Our aerated livewells are timed for convenience and feature a PowerStream nozzle, a single bilge and black thru-hulls.



FRESHCATCH PRO

Our pro livewells are aerated, timed and feature a recirculating pump to move more water and oxygen into the tanks to keep fish active. Highlights include black thru-hulls and PowerStream aerator and nozzle.



	20 X2 PHANTOM OS	20 X2 PHANTOM	18 X2 PHANTOM	172 OSPREY	162 OSPREY	162 PRO TRACER	160 PRO LODGE	2072 PRO SPORTSMAN CC	2072 PRO SPORTSMAN DC	2072 PRO SPORTSMAN T	1872 PRO SPORTSMAN CC	1872 PRO SPORTSMAN DC	1872 PRO SPORTSMAN T	1866 PRO SPORTSMAN	1866 SPORTSMAN	1660 PRO SPORTSMAN	1660 SPORTSMAN
COLORS																	
Blue	S	S	S
Black	S	S	S
White	S	S	S	S	S	S	S	S	S	S	S	S	S	S	S	S	S
Red	S	S	S	S	S	S
Wave Blue	S	S	S	S	S	S
Beige	S	S	S	S	S	S	S	S	S	S
Gray	S	S	S	S	S	S	S
Silver Metallic with Black Stripe
HULL																	
V-Hull	S	S	S	S	S	S	S	S	S	S
Mod V-Hull	S	S	S	S	S	S	S
Semi V-Hull
FLOOR/CARPET																	
Treated Floor with Lifetime Warranty	S	S	S	S	S	S	S	S	S	S	S	S	S	S	S	S	S
Vinyl Floor Covering	S	S	S	S	S	S	S	S	S	S	S	S	S	S	S	S	S
CONSOLE/DASH																	
Safety Glass Windshield	S
Curved Safety Glass Windshield	.	.	.	S	S
Welded Safety Glass Windshield	S	S	S
Elevated Console	S	S	S	S	S	S
Tachometer	S	S	S	S	S
Speedometer	S	S	S	S	S
Volt Meter	S	S	S	S	S	.	S	S	S
Fuel Gauge	S	S	S	S	S	S	S
LIVEWELL																	
Stern Livewell (gal.)
Bow Livewell (gal.)	.	.	.	(26)	(26)	(26)	(26)
TROLLING MOTOR																	
Trolling Motor Plug
SEATING																	
Seat Storage Boxes	2	0	0	0	0	0	0	0	0	0	0
Seat Storage Boxes with Hatch	2	3
Deluxe Helm & Companion	0	0	0
High-back Cushioned/Foldable	2	2
Pedestals	2	2	2	2	2	.	1	0	0	0	0	0	0	0	0	0	0
Movable Helm Pedestal with Slider
Jump Seats	0	0	0	0	0	0	0
Fishing Seats
Seat Bases
Seats
STORAGE																	
Under-console Storage with Shelf	S	S	S	S	S	S
Bow Storage	S	S	S	S	S	S	S	S	S	S	S	S	S	S	S	S	S
Open Rod Storage	S	S	S	S	S	S	S	S	S	S	S	S	S	S	S	S	S
Port Rod Storage
MISCELLANEOUS																	
Tackle Tray	S	S	S	S	S	S	S	S	S	S	S	S	S	S	S	S	S
Toe Holds	S	S	S	S	S	S	S	S	S	S	S	S	S	S	S	S	S
Navigation Lights	S	S	S	S	S	S	S	S	S	S	S	S	S	S	S	S	S
Steering	S	S	S	S	S	S	Tiller	S	S	Tiller	S	Tiller	Tiller	Tiller	Tiller	Tiller	Tiller
Tilt Steering	.	.	.	S	S
Hydraulic Tilt Steering	S	S	S	0	0
Bilge Pump	S	S	S	S	S	S	S	S	S	S	S	S	S	S	S	S	S
NMMA Certification	S	S	S	S	S	S	S	S	S	S	S	S	S	S	S	S	S
Injected Foam Flotation	S	S	S	S	S	S	S	S	S	S	S	S	S	S	S	S	S
Bow Rails	0	0	0	0	0	S	0
Coaming Gunnel with Watershed Channel	S	S	S	.	.	.	S	S	S
Cleats	S	S	S	.	.	.	S	S	S
In-floor Fish Box	0	0	0	S	S
Offshore Bracket with Auxiliary Mount	S	S	S
Bow Fish Box	S	S	S	S	S	S	S	S	S
Transom Fish Box with Sink Basin	S	S	S
Transom Doors	0	0	0	0	0	0	0	.	.	0	0	0	0	0	0	0	0
Wash-down Kit	0	0	0	0	0	0	0	0	0	0	0	0	0	0	0	0	0
Tower	0	0	0	0	0	0	0	.	.	0	0	0	0	0	0	0	0
Twice-baked Urethane Paint
Three-step Boarding Ladder
CANVAS																	
Fisherman's Top	0	0	0	S	S	S
Side Curtains	0	0	0	S	S	S
Walk-through Curtain	0	0	0	S	S	S
Drop Curtain	0	0	0	S	S	S
Mooring Cover

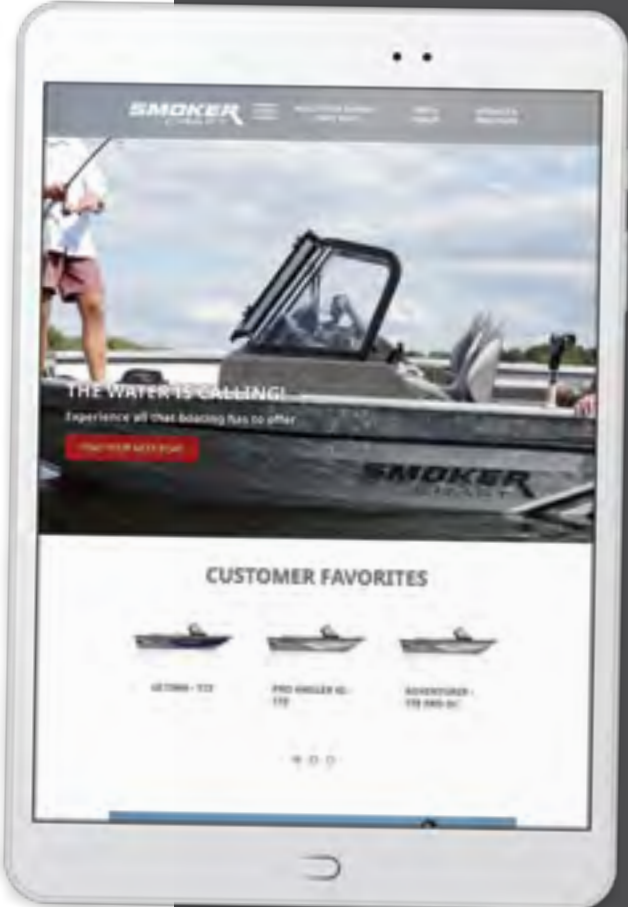

To see more information on our fine Smoker Craft boats, visit smokercraft.com.

LEGEND
 S | Standard O | Option . | Not Available
 A | Aerated T | Timed R | Recirculating P | Pump Out



SMOKER
CRAFT

TO SEE MORE INFORMATION ON OUR FINE
SMOKER CRAFT BOATS, VISIT SMOKERCRAFT.COM

TO TALK TO THE DEALER NEAREST YOU, DIAL 866-719-7873.
Connects directly to dealer. Please call during business hours.